

# WSN Based Advanced Irrigation Vehicle Operated Using Smartphone (AGRI-BOT)

<sup>[1]</sup> Niranjan L, <sup>[2]</sup> Swathi Lakshmi, <sup>[3]</sup> Sushma Behera

<sup>[1]</sup> Department of Electronics and Communication, R R Institute of Technology, Chikkabanavara, Bangalore.

---

**Abstract** - This paper explores the possibility of providing in agricultural mechanism. This robotic vehicle is an agricultural machine of an impressive power and incredible soil clearing capacity. The entire system is designed using the proteus software where each of the module is controlled depending on the crop. Here the system gives the advance version of and methods to sow, plow, water and cut the crops with minimum man power and labor, which makes it an efficient vehicle. The system will cultivate the farm by knowing the row and column at a fixed distance. The machine is controlled through the Bluetooth medium using an Android smart phone. The entire system is designed using the well know proteus software and the coding is done using keil c version of ARM Processor. The calculation, processing and monitoring is noted down and the entire system is developed using motors, sensors and controller.

**Key words:** wireless, speed control, dc motors, micro controller, android, Bluetooth, H-bridge.

---

## I. INTRODUCTION

In the field of agriculture, numerous operations for handling heavy material are performed. as an example, in vegetable cropping, staff ought to handle heavy vegetables within the harvest season. additionally, in organic farming, that is quick gaining quality, staff ought to handle serious compost baggage within the fertilizing season. These operations are boring, repetitive, or need strength and ability for the staff. In the 1980s several agricultural robots were started for analysis and development. Kawamura and co-workers developed the fruit gather in orchard. Grand and associates developed the apple gather automaton. They have been followed by several different works. several of the works concentrate on structure systems style [1] (e.g., mechanical systems design) of the automaton and report realization of the fundamental actions in actual open fields. However, several of the robots aren't within the stages of diffusion however still within the stages of analysis and development. it's necessary to seek out rooms to attain higher performance and lower value of the robots. Agriculture involves the systematic production of food, feed, fiber, and different product. Additionally, to manufacturing food for humans and animals, agriculture also produces cut flowers, timber,

fertilizers, animal hides, leather, and industrial chemicals.

A automaton could be a machine which will be programmed and reprogrammed to try to to certain tasks and typically consists of a manipulator like a claw, hand, or tool hooked up to a mobile body or a stationary platform. Autonomous robots work utterly beneath the control of a computer program. They usually use sensors to collect information regarding their surroundings in order to navigate. Tele-managemental robots work below the control of humans and/or pc programs. unmanned robots are controlled by humans with a controller like a joystick or another hand-held device. The word „robot“ came from the Czech word „robot“, which implies forced labour, or work. It was 1st utilized in the play R.U.R., Rossum's Universal Robots, written in 1921 by a Czech dramatist named Karel Capeck. Isaac Asimov was the primary person to use the term „robotics in “Runaround,” a brief story printed in 1942.

## II. DESCRIPTION

This project is divided into two modules i.e., the transmitter and the receiver (Agribot). The transmitter i.e., the remote has been equipped with android phone and Bluetooth, which have been interfaced using microcontroller 89C2051. There are

4 keys for controlling the robot. 4 keys are used for the direction control i.e., moving forward, backward, right turn and left turn [2].

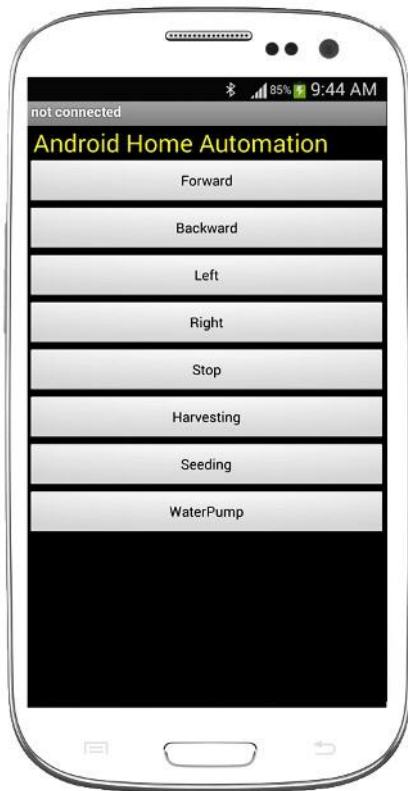

**Fig. 1: Transmitter Module**

Depending on the key pressed the controller encodes the data to the RF transmitter where the data will be modulated and transmitted. The RF transmitter is a three-pin module in which first is the input that is connected to the micro controller and the next two pins are Vcc and ground respectively. This is an in-built module, which is available in the market.

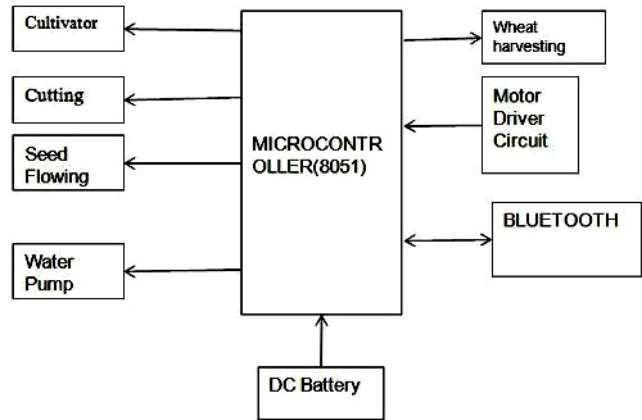
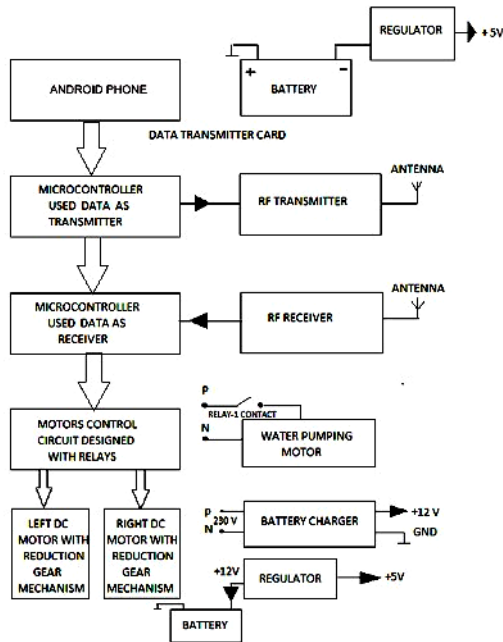

**Fig. 2: Receiver module in vehicle**

### III. BASIC CONCEPT & THE IMPLEMENTATION OF THE SYSTEM

The concept is implemented using the Bluetooth module [4]. Emphasis being given to presentation of idea. The implementation is based around the well-known microcontroller originally designed by Intel but the chips that we are using were manufactured by the Atmel corp. Although any other microcontroller could be used without any major change. The only direct impact will be only in the software or the assembly code written for the microcontroller.

**International Journal of Engineering Research in Electronics and Communication  
Engineering (IJERECE)  
Vol 4, Issue 6, June 2017**



**Fig. 3: Block Diagram of working principle**

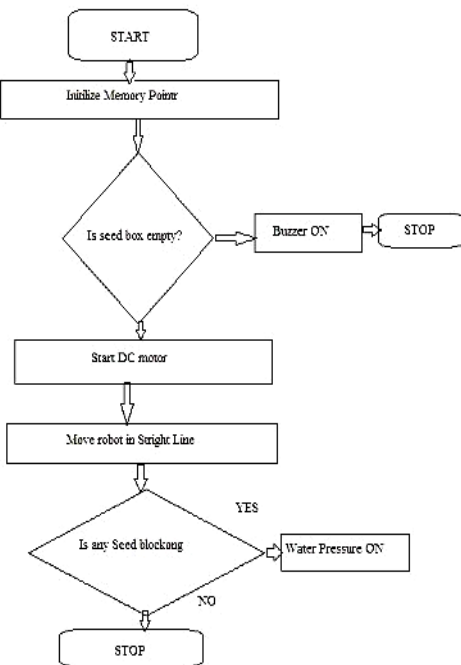
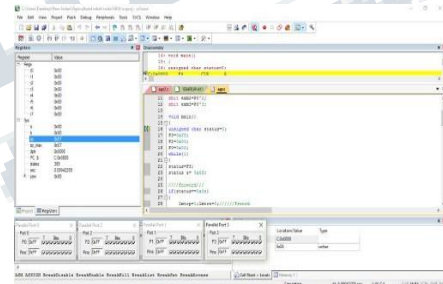

**Fig. 4: Seeding & water pumping Flow diagram**

At first initialize memory pointer in microcontroller memory. The distance between seed is dependent on the cultivation. The fixed row and column are used to tow the machine is a particular direction and for a fixed area. The seed are harvested from the machine later if the seed box is empty, the controller informs the user to fill the box using the Bluetooth module. The machine has one more advantage where it can identify which seed has to harvest and at what depth it has to be. This makes the system very convenient for the farmers to seed different crops in a limited space. The system has water tank which helps to water the seeding while it is being harvested. The entire system is controlled using the smart phone via the Bluetooth.

**IV. EXPECTED RESULTS**

**A. Initialization Mode**



**Fig. 5: Initialization Mode**

**B. Real time Mode**

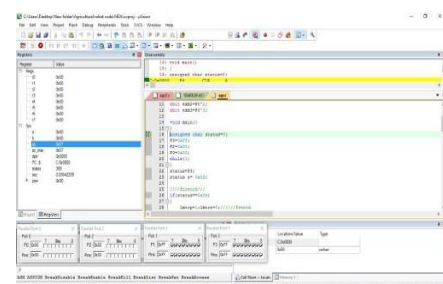

**Fig. 6: Simulation of Real-time Situation**

In the real time mode the output of each port is described in Fig. 6 Fig 7, Fig 8, Fig 9, Fig 10 and Fig 11.

In the initialization mode, the output of each port is described in Fig. 5, the port 1 is used for Bluetooth module, the port 2 which specifies the basic functions and port 3 motor drive circuit. In this scenario, the relay directly connected to the motor which runs in high speed.

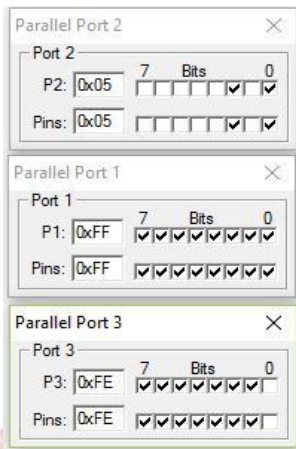

**Fig. 7: Simulation Result for forward Direction**

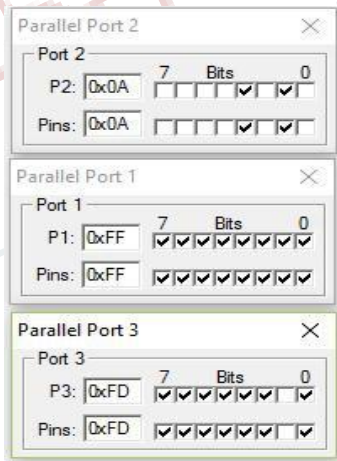

**Fig. 8: Simulation Result for Backward Direction**

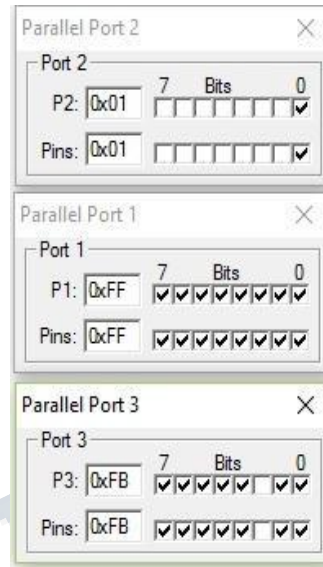

**Fig. 9: Simulation Result for Right Direction**

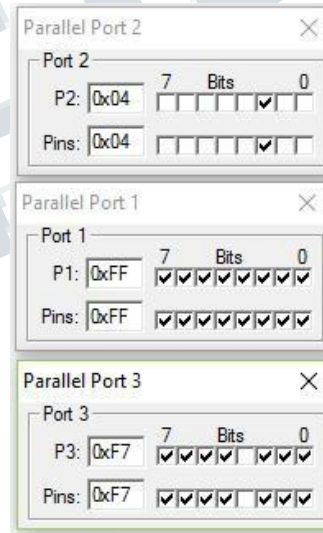

**Fig. 10: Simulation Result for Right Direction**

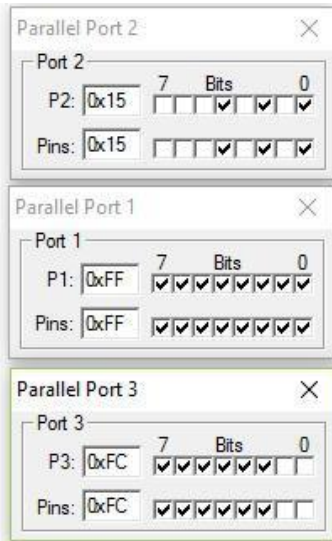

**Fig. 11: Simulation Result for Right Direction**

As we can see here the port 3 is activated at the pin P3.0 where the relay is activated and the robot moves forward direction, at the pin P3.1 where the relay is activated the robot moves backward direction, at the pin P3.0 and P3.1 takes stop action for robot, at the port P3.2 the robot moves right direction and at the port P3.3 the robot moves left direction.

**V. REAL-TIME SETUP**

1. Microcontroller 89C52
2. H-bridge L293D
3. Bluetooth Module (HC-05)
4. RF Receiver Module (433.92Mhz)
5. RF Transmitter Module (43 3.92Mhz)
6. Relay circuit.
7. Power Supply Unit.

**Table I: Simulation Result Vs Real Time**

Task	Simulation Results in seconds	Results in Real Time (seconds)	Differences in seconds
------	-------------------------------	--------------------------------	------------------------

Water Pump	1.5	2.1	0.6
Buzzer	2.2	3.43	1.23
Replay	3.4	4.86	1.46
Motor	0.75	1.23	0.45

**VI. SNAP-SHOT OF THE MODULE**

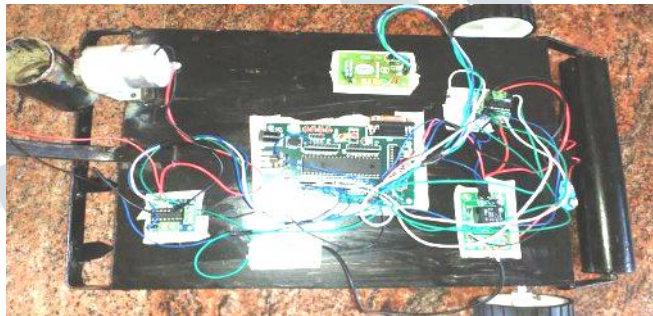

**Fig. 12 Robot with the relevant modules**



**Fig. 13: Complete view of the proposed system**

**VII. CONCLUSION**

This paper provides a short review of the analysis on technologies in agricultural vehicles over the past twenty years. though the analysis developments are rife, there are some shortcomings (e.g., low lustiness

**International Journal of Engineering Research in Electronics and Communication  
Engineering (IJERECE)  
Vol 4, Issue 6, June 2017**

---

of versatility and liableness of technologies) that are delaying the improvements needed for development of the steerage systems. It is concluded that either GPS and machine vision technologies are going to be „fused. along or one of them are „fused. with another technology (e.g., optical maser radar) because the trend development for agricultural vehicle steerage systems. the application of recent popular robotic technologies for agricultural steerage systems can augment the belief of agricultural vehicle automation within the future. In agriculture, the opportunities for robot-enhanced productivity are huge - and also the robots are appearing on farms in numerous guises and in increasing numbers. the opposite issues related to autonomous farm equipment will probably be overcome with technology. This equipment may be in our future, however there are vital reasons for thinking that it's going to not be simply substitution the human driver with a pc. it's going to mean a rethinking of how crop production is finished. Crop production is also done higher and cheaper with a swarm of tiny machines than with a number of giant ones. one in all the benefits of the smaller machines is that they might be a lot of acceptable to the non-farm community. the roles in agriculture are a haul, dangerous, need intelligence and fast, although extremely repetitive choices thus robots will be rightly substituted with human operator. the upper quality merchandise is sensed by machines (color, firmness, weight, density, ripeness, size, shape) accurately. Robots will improve the standard of our lives however there are downsides.

#### REFERENCES

- [1]. S. Blackmore and K. Apostolidi, “The European farm of tomorrow,” Transactions of the ASABE, vol. 18, no. 1, p. 6, 2011.
- [2]. Y. Chen, X. Peng, and T. Zhang, “Application of wireless sensor networks in the field of agriculture,” in Proceedings of the ASABE Annual International Meeting, publication no. 1110617, Louisville, Ky, USA, 2011.
- [3]. Ryerson A E F, Zhang Q. Vehicle path planning for complete field coverage using genetic algorithms. Agricultural Engineering International: the CIGR Ejournal. Manuscript ATOE 07014. Vol. IX (July). 2007.
- [4]. J. A. Heraud and A. F. Lange, “Agricultural automatic vehicle guidance from horses to GPS: how we got here, and where we are going,” in Proceedings of the Agricultural Equipment Technology Conference, vol. 33, ASABE publication no. 913C0109, pp. 1-67, Louisville, Ky, USA, 2009.
- [5]. T. Bakker, K. Asselt, J. Bontsema, J. Müller, and G. Straten, “Systematic design of an autonomous platform for robotic weeding,” Journal of Terramechanics, vol. 47, no. 2, pp. 63.73, 2010. View at Publisher •E View at Google Scholar •E View at Scopus
- [6]. C. Cariou, R. Lenain, B. Thuilot, and M. Berducat, “Automatic guidance of a four-wheel-steering mobile robot for accurate field operations,” Journal of Field Robotics, vol. 26, no. 6-7, pp. 504.518, 2009. View at Publisher •E View at Google Scholar •E View at Scopus
- [7]. Y. Nagasaka, H. Saito, K. Tamaki, M. Seki, K. Kobayashi, and K. Taniwaki, “An autonomous rice transplanter guided by global positioning system and inertial measurement unit,” Journal of Field Robotics, vol. 26, no. 6-7, pp. 537.548, 2009. View at Publisher •E View at Google Scholar •E View at Scopus

**International Journal of Engineering Research in Electronics and Communication  
Engineering (IJERECE)  
Vol 4, Issue 6, June 2017**

---

[8]. R. A. Tabile, E. P. Godoy, R. R. D. Pereira, G. T. Tangerino, A. J.V. Porto, and R. Y. Inamasu, "Design and development of the architecture of an agricultural mobile robot," *Engenharia Agricola*, vol. 31, no. 1, pp. 130-142, 2011. View at Publisher E View at Google Scholar

[9]. Dorhout, D, 2011, Prospero: Robot Farmer, [dorhoutrd.com/home/prospero\\_robot\\_farmer](http://dorhoutrd.com/home/prospero_robot_farmer) (accessed December 9, 2011)

[10]. Harvest Automation, agricultural Market Analysis, [harvestai.com/agricultural-robots-manual-labor.php](http://harvestai.com/agricultural-robots-manual-labor.php) (accessed December 5, 2011)

[11]. Advanced Ag Solutions, 2011. Advanced Ag Solutions - Crops scouting. Available from: (accessed 14.02.2012).

[12]. Hamner, B., Bergerman, M., Singh, S., 2011. Autonomous orchard vehicles for specialty crop production. s.l., ASABE Paper No. 11-071. St. Joseph, Mich.: ASABE.